

姿図 (S=1/4)

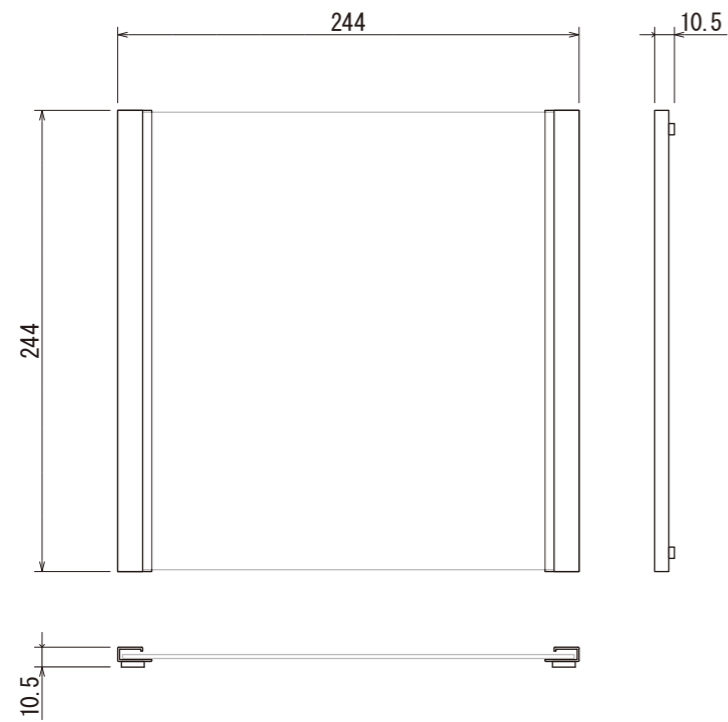

断面詳細図 (S=1/1)

